

FLOORS, INTERIOR

Wood Subfloor, 16" o.c. Joist Spacing

EGP (Exterior Glue Plywood), Latex-Portland Cement Mortar

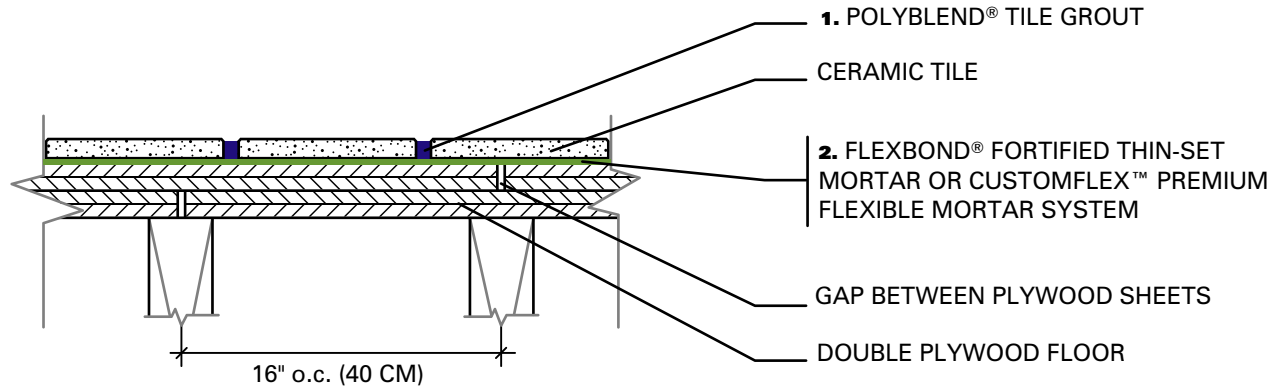

1. Grout Options:

- Polyblend® Sanded Tile Grout
- Polyblend® Non-Sanded Tile Grout

2. Latex Portland Cement Mortar Options:

- MegaFlex™ Ultimate Thin-Set Mortar
- FlexBond® Fortified Thin-Set Mortar
- VersaBond Flex™ Fortified Thin-Set Mortar
- PremiumPlus® Standard Thin-Set Mortar mixed with CustomFlex™ Ultra-Strength Thin-Set Additive
- CustomFlex™ Premium Flexible Mortar System – MasterBlend™ Standard Thin-Set Mortar mixed with CustomFlex™ Ultra-Strength Thin-Set Additive
- PremiumPlus® Standard Thin-Set Mortar mixed with Acrylic Mortar Admix
- MasterBlend™ Standard Thin-Set Mortar mixed with Acrylic Mortar Admix
- Complete Contact Mortar
- Porcelain Tile Fortified Thin-Set Mortar

Rapid Setting Mortars:

- RapidSetting Mortar System
- SpeedSet™ Fortified Thin-Set Mortar
- OptiCure™ Fortified Thin-Set Mortar
- Complete Contact Mortar RS

Medium Bed Mortars:

- Marble & Granite Fortified Premium Mortar
- Medium Bed Mortar mixed with Acrylic Mortar Admix
- RapidSetting Mortar System
- Complete Contact Mortar
- Complete Contact Mortar RS

Moisture-Sensitive Stone and Tile Mortars:

- OptiCure™ Fortified Thin-Set Mortar

These drawings have been taken from Tile Council of America's (TCA) Handbook for Ceramic Tile Installation. For your convenience, Custom Building Products options are substituted for TCA's generic product descriptions. Please refer to the Handbook for complete information.



CUSTOM[®]
BUILDING PRODUCTS